

VISATON Widerange Speakers (suitable for industry applications)

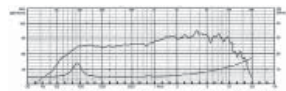

Industry



FR16 WP/4
Saltwater resistant 16 cm (6.5") full-range speaker with moulded plastic cone, plastic basket and grille. Absolutely corrosion-resistant and waterproof due to encased magnet and silicon-coated leads. White or black colour

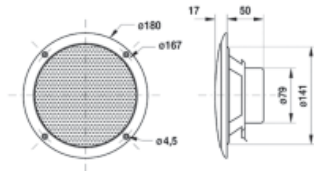

Technical Parameters	FR 16 WP/4
Diameter	180 mm
Depth	50 mm
Rated Noise Power	60 W
Short Term Maximum Power	80 W
Impedance	4 Ω
Resonant Frequency	85 Hz
Rated Frequency Range	60-15000 Hz
Sensitivity	86 dB

Part No.	Ord.No.
S FR 16 WP/4 WH	46289
O FR 16 WP/4 BK	61441



Industry

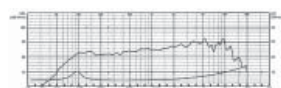

FR 13 WP/4
Saltwater resistant 13 cm (5") full-range driver with moulded plastic cone, plastic basket and grille. Absolutely corrosion-resistant and waterproof due to encased magnet and silicon-coated leads. White or black colour

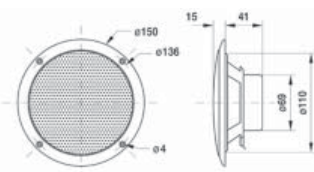

Technical Parameters	FR 13 WP/4
Diameter	150 mm
Depth	41 mm
Rated Noise Power	40 W
Short Term Maximum Power	60 W
Impedance	4 Ω
Resonant Frequency	100 Hz
Rated Frequency Range	70-16000 Hz
Sensitivity	85 dB

Part No.	Ord.No.
S FR 13 WP/4 WH	46307
O FR 13 WP/4 BK	61440



Industry

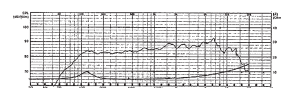

FR 10 WP/4
Saltwater resistant 10 cm (4") full-range driver with moulded plastic cone, plastic basket and grille. Absolutely corrosion-resistant and waterproof due to encased magnet and silicon-coated leads. Clear-cut high-range output. White or black colour

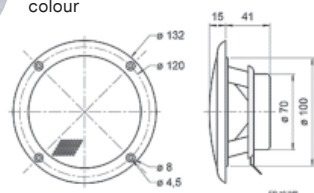

Technical Parameters	FR 10 WP/4
Diameter	132 mm
Depth	41 mm
Rated Noise Power	20 W
Short Term Maximum Power	30 W
Impedance	4 Ω
Resonant Frequency	120 Hz
Rated Frequency Range	80-16000 Hz
Sensitivity	85 dB

Part No.	Ord.No.
S FR 10 WP/4 WH	46323
O FR 10 WP/4 BK	61439



Industry

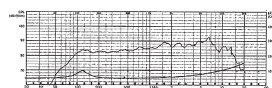

FRS 10 WP/4
Saltwater resistant 10 cm (4") full-range driver with glass fibre cone, plastic basket and grille. Long time weather proved and therefore especially suited for out-door sound reinforcement systems, swimming pools, sauna and speaker for boats, ships and open vehicles. Also suitable for model boat applications. 120 °C temperature resistant.

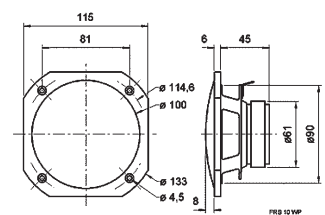

Technical Parameters	FRS 10 WP/4 WH / FRS 10 WP/4 BK
Diameter	115 mm
Depth	45 mm
Rated Noise Power	25 W
Short Term Maximum Power	50 W
Impedance	4 Ω
Resonant Frequency	190 Hz
Rated Frequency Range	190-19000 Hz
Sensitivity	90 dB

Part No.	Ord.No.
O FRS 10 WP/4WH	46318
O FRS 10 WP/4BK	46320

PL13BS/100V



100 V transformer

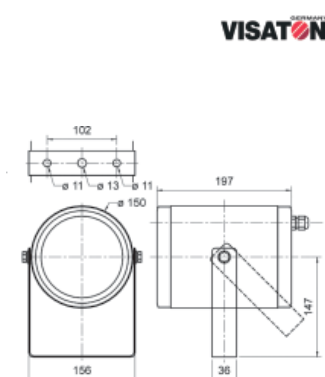
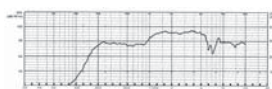

Technical Parameters	PL13BS/100V
Diameter	150 mm
Depth	197 mm
Rated Noise Power	15 W / 7,25 W / 3,75 W
Rated Frequency Range	160-15000 Hz
Sensitivity	96 dB

Part No.	Ord.No.
S PL13BS/100V	61371