

# Basic Electrical Parameters of Reed Switch Products

Pull-In (PI) is described as that point where the contacts close. Using a magnet, it is usually measured as a distance from the Reed Switch to the magnet in mm (inches) or in field strength AT, mTesla, or Gauss. In a coil, the Pull-In is measured in volts across the coil, mA flowing in the coil, or ampere-turns (AT). Generally, this parameter is specified as a maximum. No matter how well the reed blades are annealed, they will still have a slight amount of retentivity (a slight amount of magnetism left in the blades after the magnetic field is removed or eliminated from the Reed Switch). To obtain consistent Pull-In and Drop-out results, saturating the Reed Switch with a strong magnetic field first, before taking the Pull-In measurement will produce more consistent results. (see Figure #5).

When measured in a coil, or specifically, a Reed Relay, the Pull-in is subject to changes at different temperatures, and is usually specified at 20 °C (see Figure #6)

(Figure #6. The Pull-in and Drop-out points will change with temperature at the rate of 0.4%/°C.)

Pull-in/Drop-out Temperature Effects

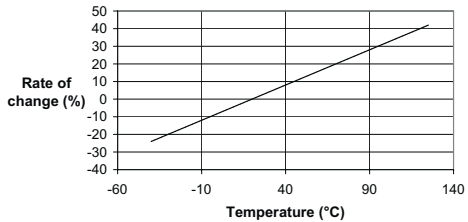

Here, because the copper coil wire expands and contracts with temperature, the Pull-In or operate point will vary with temperature by 0.4%°C. Well designed relays usually take this parametric change into consideration in the design and specification.

**Drop-Out (DO)** is described as that point where the contacts open and has similar characteristics as the Pull-In

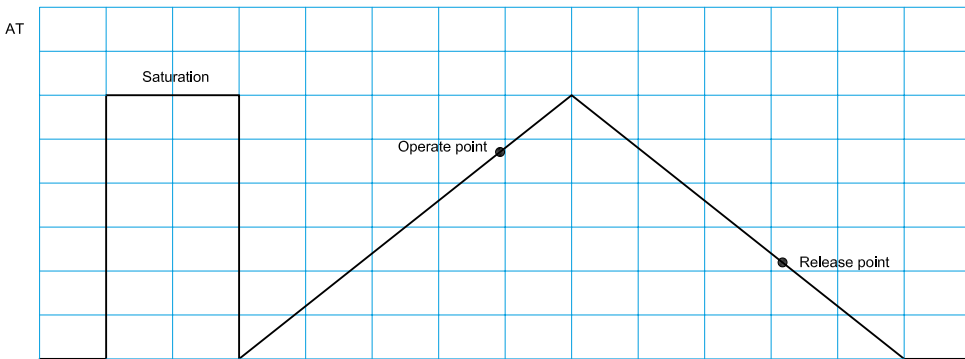

(Figure #5. For most accurate results, saturate the contrast with a magnetic field, before testing for Pull-in and Drop-out.)

above. It is also described as release or reset voltage current or AT.

**Hysteresis** exists between the Pull-In and Drop-Out and is usually described in the ratio DO/PI expressed in %. The hysteresis can vary depending upon the Reed Switch design, (see Figure #7), where variations in plating or sputtering thickness, blade stiffness, blade overlap, blade length, gap size, seal length, etc. will all influence this parameter. See Figure #29 for example of hysteresis when using a magnet to handle a Reed Switch.

Drop-out vs. Pull-in

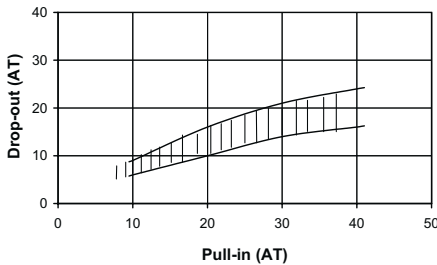

(Figure #7. The Pull-in and Drop-out ranges are shown. Note that variation in hysteresis is for low ampere turns (AT) is very small and increases with higher AT.)

**Contact Resistance** is the DC resistance generated by the reed blades (bulk resistance) and the resistance across the contact gap. Most of the contact resistance resides in the nickel / iron reed blades. Their resistivity is  $7.8 \times 10^{-8}$  Ohm/m and  $10.0 \times 10^{-8}$  Ohm/m, respectively. These are relatively high when compared to the resistivity of copper, which is  $1.7 \times 10^{-8}$  Ohm/m. Typical contact resistance for a Reed Switch is approximately 70 mOhm, 10 to 25 mOhm of which is the actual resistance across the contacts. In a Reed Relay, many times the relay pins will be nickel/iron improving the overall magnetic efficiency but adding bulk resistance to the contact resistance. This increase can be in the order of 25 mOhm to 50 mOhm (See Figure #8).

(Figure #8. A representation of the bulk resistance and resistance across the contacts making up the contact resistance value in Ohms for a Reed Switch.)

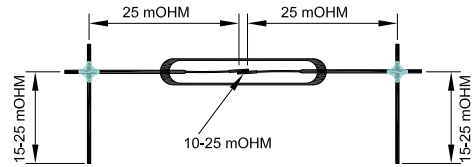

**Dynamic Contact Resistance (DCR)** is a true measure of the disposition of the contacts. As already described, the contact resistance is mostly made up of bulk resistance or lead resistance. Measuring the resistance across the Reed Switch only gives gross indication that the contacts are functional. To give a better indication of the contacts functionality, one must look at the contacts under dynamic conditions.

Opening and closing the contacts at frequencies in the range of 50 Hz to 200 Hz can reveal much more information. Switching 0.5 Volts or less with approximately 50 mA will allow enough voltage and current to detect potential problems. This testing can be carried out using an oscilloscope or may be easily digitized for more automatic testing. One should avoid test voltages greater than 0.5 Volts to avoid 'break-over'. If a Reed Switch is not properly cleaned during its manufacture, potential non-conductive films may exist that may only be of the order of a few Angstroms thick. This extremely thin film will look like an open circuit if one is switching very low signals or in currentless closing of the Reed Switch (closing the contacts before any voltage or current is applied across the contacts). Using a higher voltage while testing the contact resistance, one might miss this potential quality problem. See Figure #9.

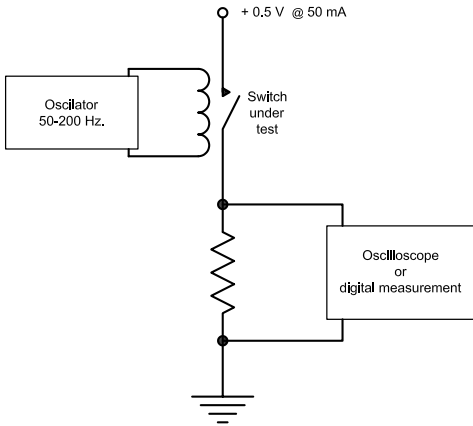

(Figure #9. A schematic diagram of a typical circuit used for measuring the dynamic contact resistance across the contacts of a Reed Switch.)

Applying the frequency described above to a coil, the contacts will operate and close in approximately  $\frac{1}{2}$  mA. The contacts may then bounce for about 100ms and undergo a period of dynamic noise for as much as  $\frac{1}{2}$  ms. This dynamic noise is generated by the contacts continuing to bounce but not opening, whereby the contact resistance varies widely where the force or pressure on the contacts varies harmonically, critically dampening in about  $\frac{1}{2}$  ms or less. See Figure #10. Once this dynamic noise dissipates, the contacts will then undergo a "wavering period". Here the contacts have closed, but will waver while closed for up to 1 ms or more. This wavering of the contacts in the coil's magnetic field generates a current through the contacts. Once this effect dissipates the contacts enter their static condition.

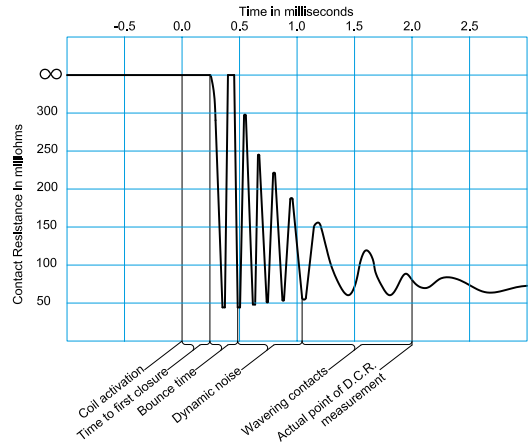

(Figure #10. A typical dynamic contact resistance portrayal showing the first closure, bouncing, dynamic noise and pattern generated by wavering contacts.)

Observing the electrical pattern produced by this dynamic test can reveal much about the quality of the Reed Switch. Generally speaking, once the coil voltage has been applied, the dynamic contact activity should settle down by  $1 \frac{1}{2}$  ms. If the contacts continue to bounce more than 250 ms, the closing force may be weak, which may result in a shortened life, particularly if one is switching a load of any size. (See Figure #11)

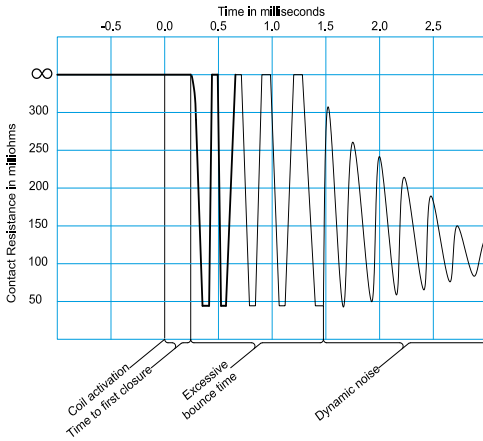

(Figure F#11. A dynamic contact resistance pattern showing excessive contact bounce.)

If the dynamic noise or the wavering contacts continue for periods longer than indicated, it may mean the Reed Switch seals are weak or perhaps overstressed. This could result in capsule cracking or breaking. Also, if the wavering produced has excessive amplitude, this could represent a condition of capsules having added stress which could produce leaking seals. In this case, outside air and moisture may seep into the capsule producing unwanted contamination on the contacts. See Figure #12 & Figure #13.

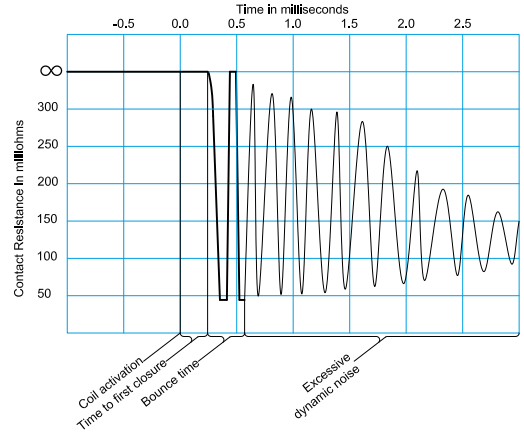

(Figure #12. A dynamic contact resistance pattern portraying excessive dynamic noise indicating potential stressed or cracked glass seal.)

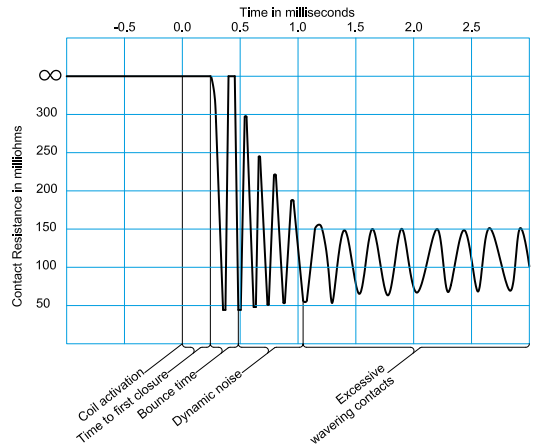

(Figure #13. A dynamic contact resistance pattern with indicated excessive contact wavering often indicates a stressed or cracked glass seal.)

Also, when the contact resistance varies by a small degree with successive closures, contamination, a leaking seal, particles, loose or peeling plating may exist, potentially shortening life expectations (See Figure #14). Varying the frequency applied to the coil sometimes produces more

subtle awareness of resonance related problems. This will also manifest itself with higher amplitude or longer times of dynamic noise or contact wavering.

low as 10 nanoVolts.

**Switching Current** refers to that current measured in Amperes DC (peak AC), switched at the point of closure of the contacts. The higher the level of current the more sustained the arcing at opening and closing and therefore the shorter the life of the switch.

**Carry Current**, also measured in Amperes DC (peak AC), is specified as the maximum current allowed when the contacts are already closed. Since the contacts are closed, much higher currents are allowed. No contact damage can occur, since the only time arcing occurs is during the opening and closing transitions. Surprisingly high pulsed currents can be specified over short durations when the contacts are closed. Conversely, unlike electromechanical armature style relays, the Reed Relay can switch or carry currents as low as femptoAmperes ( $10^{-15}$  Amperes).

**Stray Capacitance** measured in microFarads or Pico Farads is always present, to some degree, when switching any voltage and current. When switching a given voltage and current, the first 50 nanoSeconds are the most important. This is where the arcing will occur. If there is a significant amount (depending on the amount of voltage switched) of stray capacitance in the switching circuit, a much greater arc may occur, and thereby reducing life. When switching any sizable voltage, it is always a smart idea to place a fast current probe in the circuit to see exactly what one is switching in the first 50 nanoSeconds. Generally speaking, when switching voltages over 50 Volts, 50 picoFarads or more can be very significant to the expected life of the switch.

**Common Mode Voltage** is also another parameter that can have a significant effect on the life of a Reed Switch. Depending upon the circuit and the environment, common mode voltages can in effect, charge stray capacitances in the switching circuit and dramatically reduce Reed Switch life in an unexpected manner. Again, a fast current probe can reveal a startling voltage and current switched in that first 50 nanoSeconds, having no bearing on one's actual load. When line voltages are present in or near sensitive circuits, be cautious. Those voltages can be coupled into the circuit creating havoc with your life requirements. Typically, a faulty Reed Switch is blamed for this reduced life, when in actuality, it is a product of unforeseen conditions in the circuit.

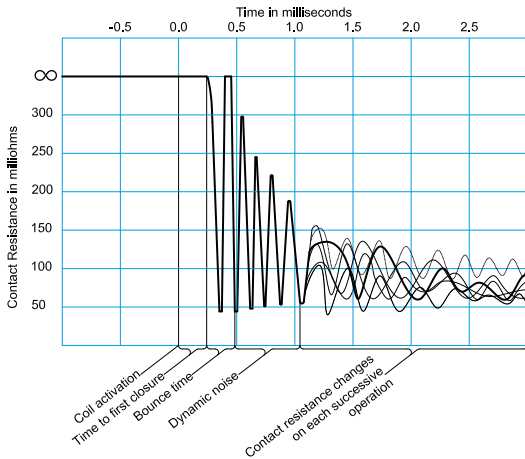

(Figure #14. A dynamic contact resistance pattern showing contact resistance changing in each successive operation indicating contact contamination.)

Any time long life, stable contact resistance, and fault free operation are conditions in your application, dynamically testing the contacts and having tight testing limits are a must.

**Switching Voltage**, usually specified as a maximum in units of Volts DC or Volts peak, is the maximum allowable voltage capable of being switched across the contacts. Switching voltages above the arcing potential can cause some metal transfer. The arc potential generally occurs over 5 Volts. Arcing is the chief cause of shorted life across the contacts. In the 5 V to 12 V range most contacts are capable of switching well into the tens of millions of operations depending on the amount of current switched. Most pressurized Reed Switches can not switch more than 250 Volts, principally because they can not break the arc occurring when one tries to open the contacts. Generally, switching above 250 Volts requires evacuated Reed Switches, where up to 10,000 Volts is possible. Switching below 5 Volts, no arcing occurs and therefore no blade wear occurs, extending Reed Switch lifetimes well into the billions of operations. Properly designed Reed Relays can switch and discern voltages as

**Switching Wattage** is the combined voltage and current switched at the time of closure. Sometimes there is confusion with this parameter. For a given switch, with a switching rating of 200 Volts, 0.5 Amperes and 10 Watts, any voltage or current switched, when multiplied together, can not exceed 10 Watts. If you are switching 200 Volts, then you can only switch 50 milliAmperes. If you are switching 0.5 Amperes, then you can only switch 20 Volts.

**Breakdown Voltage (Dielectric Voltage)** generally is higher than the switching voltage. Reed Switches stand off higher voltages because unlike the switching voltages, breaking the arc on opening is not a consideration. On larger evacuated Reed Switches, ratings as high as 15,000 Volts DC are not uncommon. Some smaller evacuated reeds can stand off up to 4000 Volts DC. Small pressurized reed switches generally withstand 250 to 600 Volts DC.

**Insulation Resistance** is the measure of isolation across the contacts and is probably one of the most unique parameters that separate Reed Switches from all other

switching devices. Typically, Reed Switches have insulation resistances averaging  $1 \times 10^{14}$  ohms. This isolation allows usage in extreme measurement conditions where leakage currents in the picoAmpere or femtoAmpere range would interfere with the measurements being taken. When testing semiconductors, one may have several gates in parallel where the switching devices have combined leakage currents that become significant in the test measurement circuit.

**Dielectric Absorption** describes the effect different dielectrics have on very small currents. Currents below 1 nanoAmpere are affected by the dielectric's tendency to slow or delay these currents. Depending upon how low a current one is measuring, these delays can be on the order of several seconds. MEDER engineers have designed Reed Relays and circuits to minimize dielectric absorption. For specific requirements call for applications help.

**Operate Time** is the time it takes to close the contacts and stop bouncing. Except for mercury wetted contacts, when the reed blades close, they close with enough force to set them in harmonic motion. This critically damped motion dissipates rapidly due to the relatively strong spring force of the reed blades. One generally sees one or two bounces occurring over a 50 ms to 100 ms period. Most small Reed Switches operate, including bounce, in the range of 100 ms to 500 ms. See Figure #15.

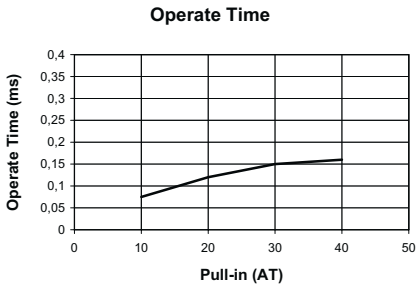

(Figure #15. A typical graph of the operate time for increasing Pull-in AT values. With higher Pull-in AT the Reed Switch gap increases taking a longer time for the contacts to close.)

**Release Time** is the time it takes for the contacts to open after the magnetic field is removed. In a relay, when the coil turns off, a large negative inductive pulse ('kick') occurs causing the reed blades to open very rapidly. This release time may be in the order of 20 ms to 50 ms. If a diode is placed across the coil to remove this inductive voltage spike (which can be 100 Volts to 200 Volts), the contact opening time will slow to about 300 ms. Some designers require the fast release time, but cannot have the high negative pulses potentially being coupled into sensitive digital circuitry. So they add a 12 Volt to 24 Volt zener diode in series with a diode, all of which is in parallel across the coil. Here, when the coil is turned off, the voltage is allowed to go negative by the zener voltage value, which is sufficient to cause the contacts to open generally under 100 ms. See Figure #16.

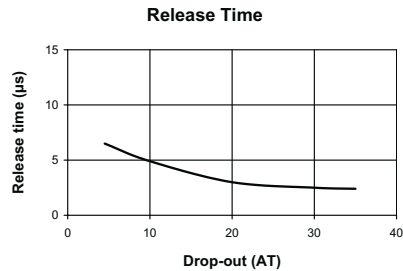

(Figure #16. A graph of the release time for increasing Drop-out AT. With increasing Drop-out AT the restoring force increases causing even faster release time.)

**Resonant Frequency** for a Reed Switch is that physical characteristic where all reed parameters may be affected at the exact resonance point of the Reed Switch. Reed capsules 20 mm long will typically resonate in the 1500 to 2000 Hz range; reed capsules on the order of 10 mm will resonate in the 7000 to 8000 range. Avoiding these specific resonance areas will insure a fault free environment for the Reed Switch. Parameters typically affected are the switching voltage and the breakdown voltage. See Figure #17.

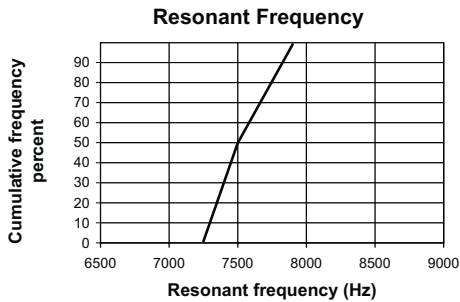

(Figure #17. A depiction of a group of 10 mm Reed Switches and its resonant frequency distribution.)

**Capacitance** across the contacts is measured in picoFarads and ranges from 0.1 pF to 0.3 pF. This very low capacitance allows switching usage, where semiconductors having 100's of picoFarads, can not be considered. In semiconductor testers, this low capacitance is absolutely critical. See Figure #18.

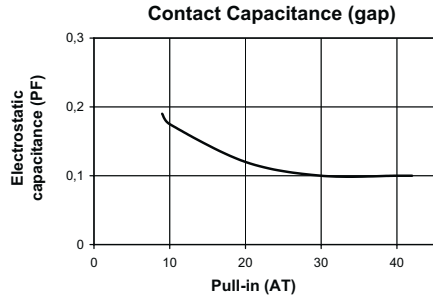

(Figure #18. As the Pull-in AT increases its gap increases, therefore reducing the capacitance across the Reed Switch.)